

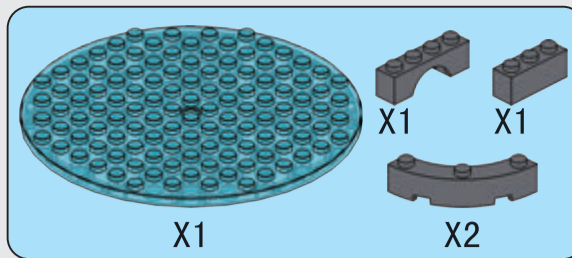

LANDMARK
COLLECTION
BIG BEN

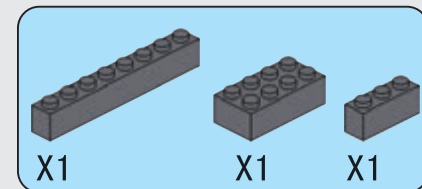

01

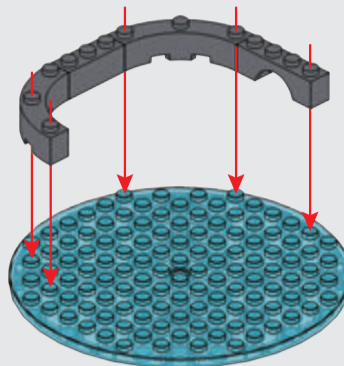

02

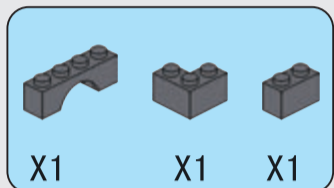
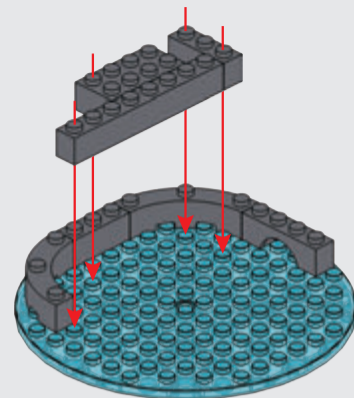

03

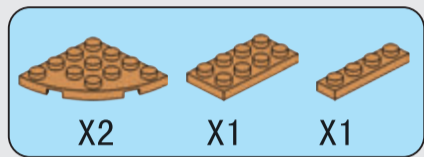
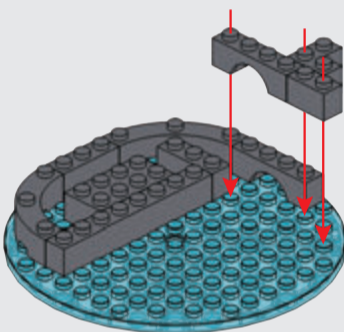

04

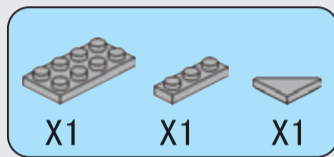
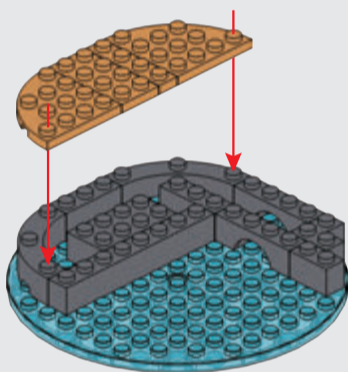

05

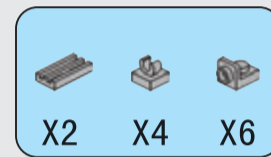
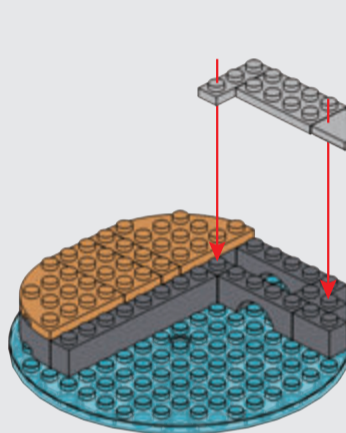

06

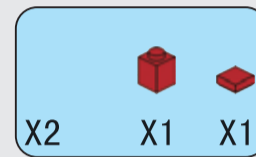
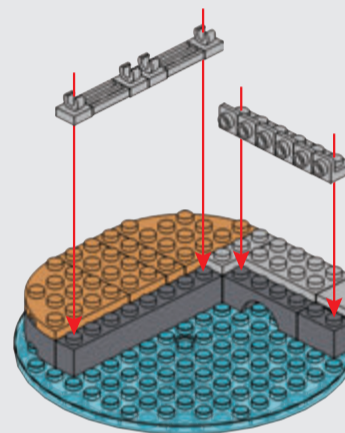

07

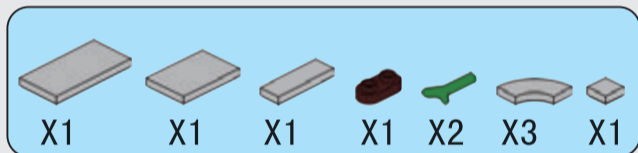
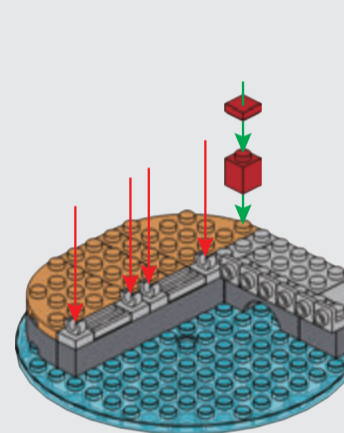

08

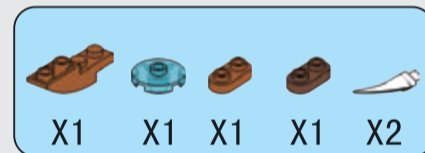
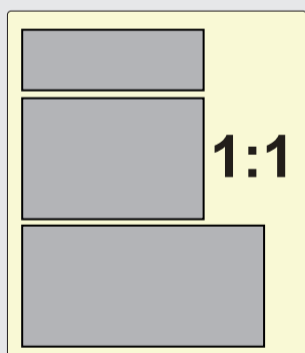
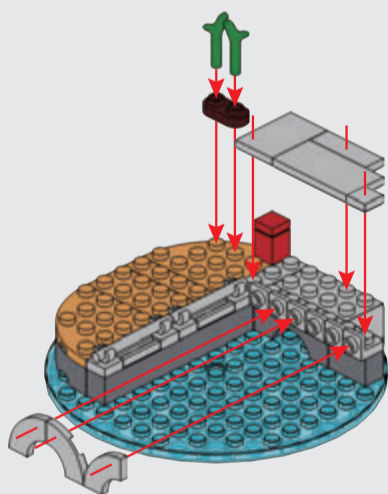

09

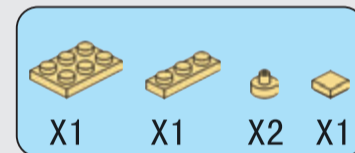
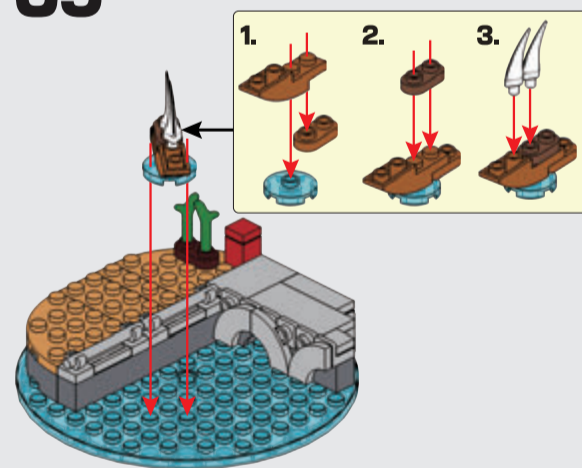

10

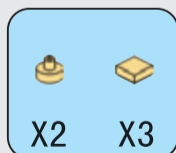
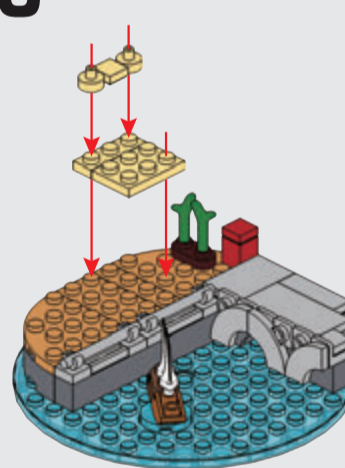

11

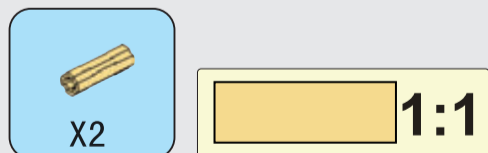
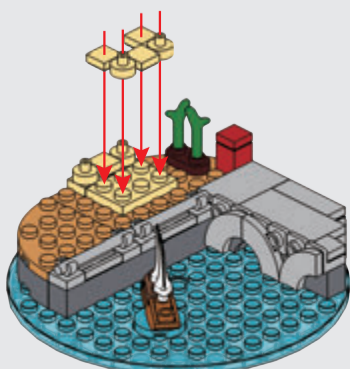

12

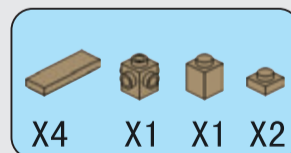
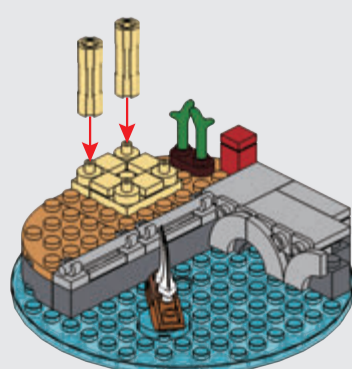

13

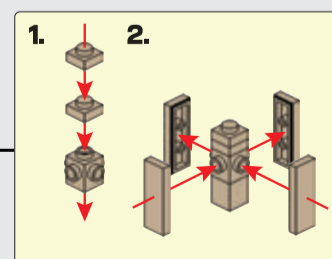
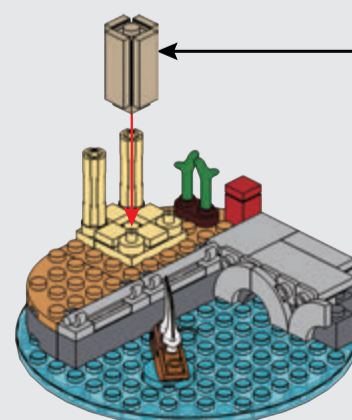



14

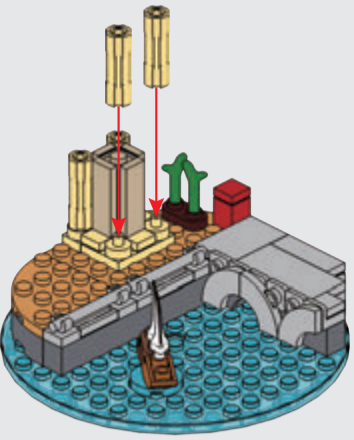

15

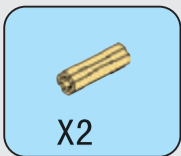
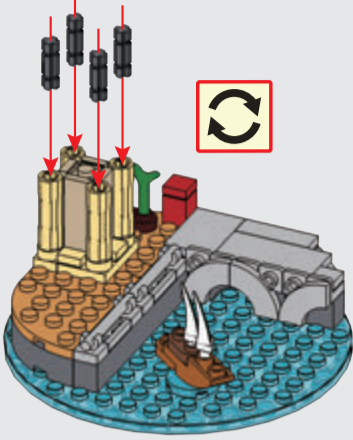

16

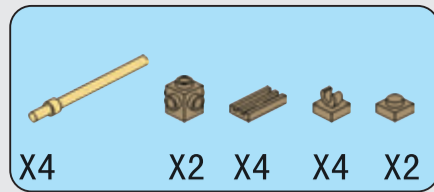
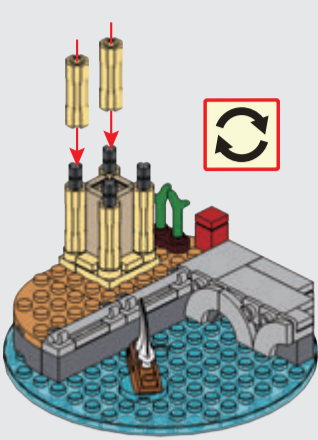

17

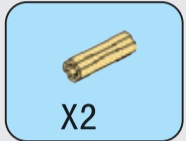
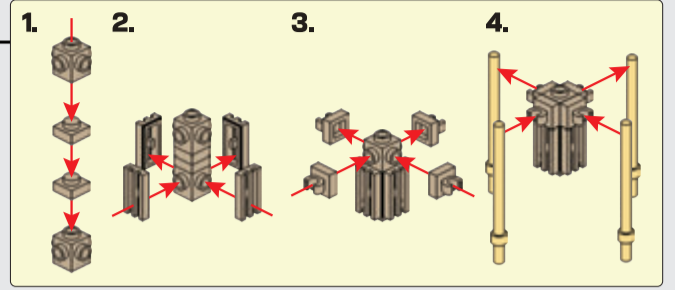
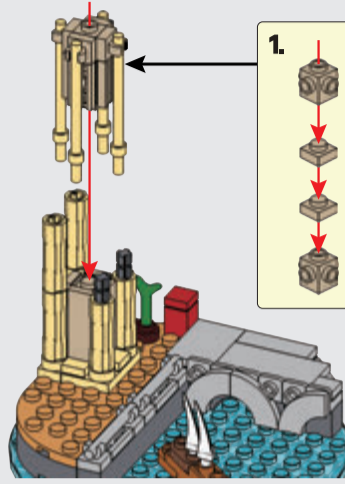

18

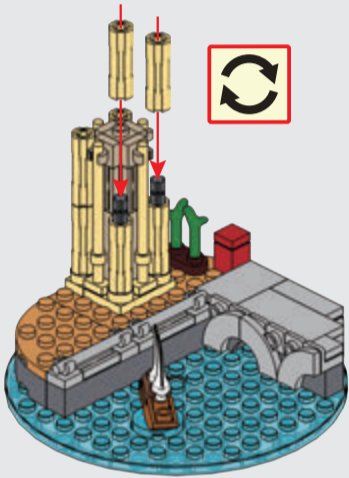

19

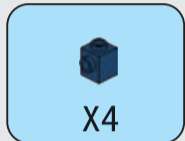
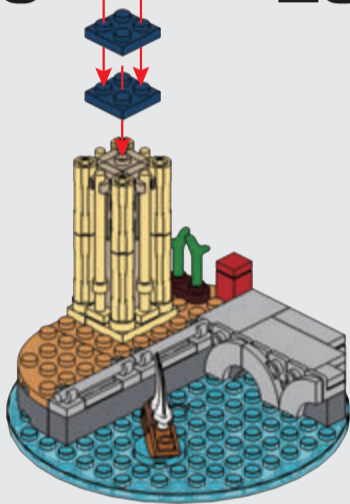

20

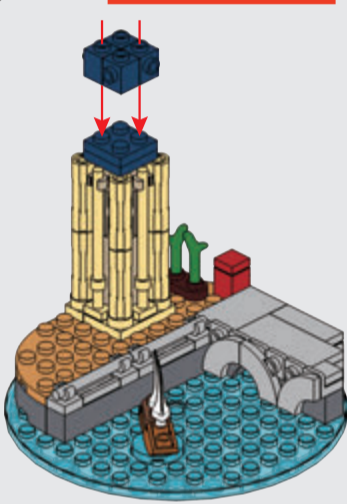

21

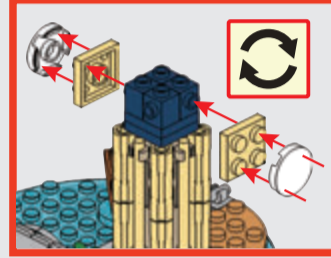
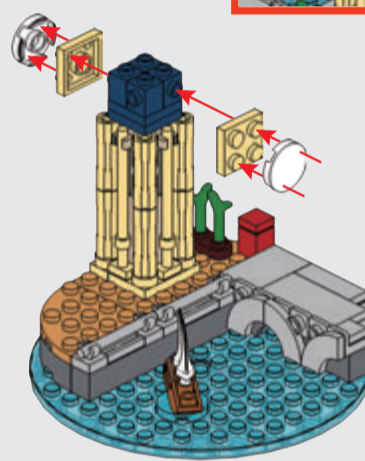

22

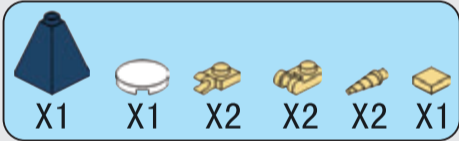
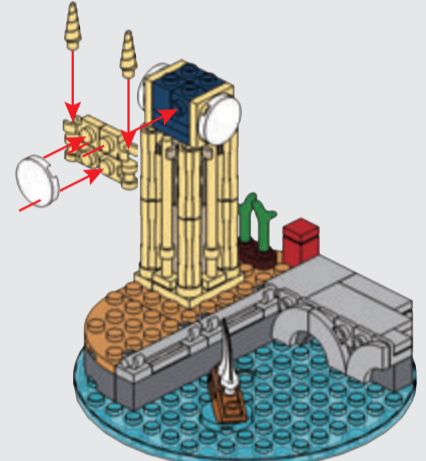

23

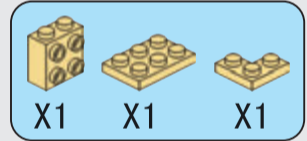
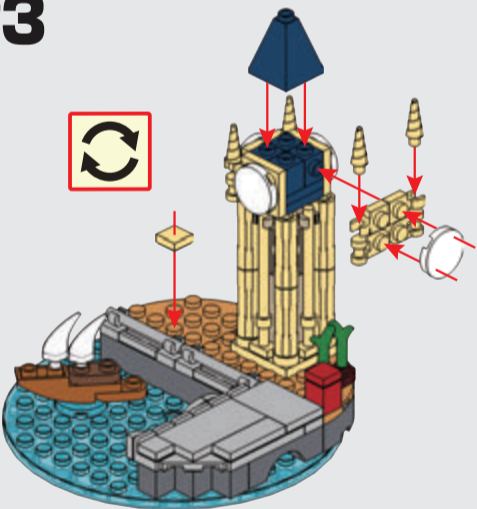

24

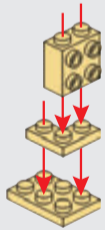

25

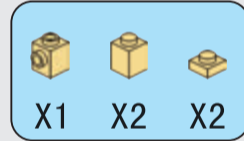
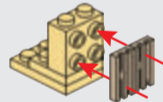

26

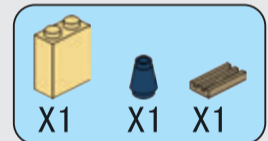
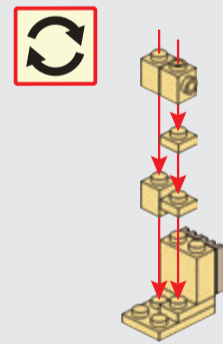

27

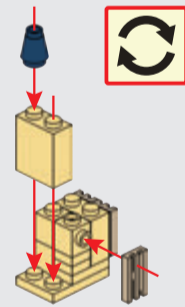

28

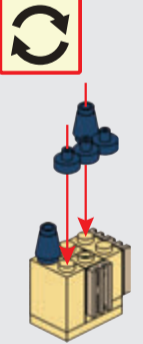

29

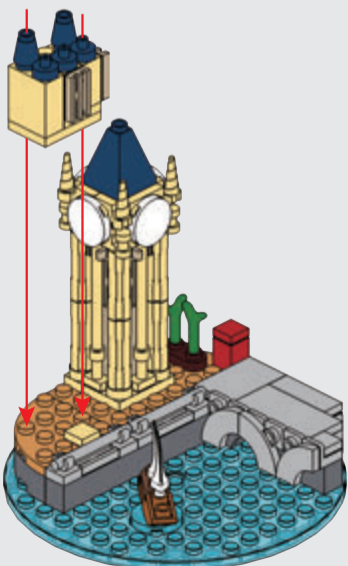

30

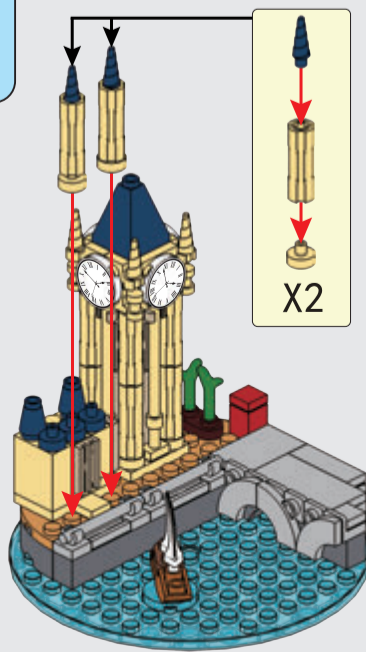
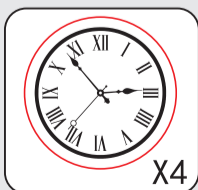

ALPHA GROUP CO., LTD.
Alpha Animation Industrial Area, Jinhong Road East & Fengxiang Road North, Chenghai District, Shantou, Guangdong, P.R.China(515800)
Tel: (86) 20-38983278 Fax:(86) 20-87358278
E-mail: auldeytoys@auldey.cn

AULDEY TOYS OF NORTH AMERICA, LLC.
13048 Valley Blvd, Fontana, CA92335, USA
Tel: 1-800-328-7363
customerservice@alphagroup-us.com
www.alphatoys.com

MADE IN CHINA • FABRIQUÉ EN CHINE • HERGESTELLT IN CHINA • FABBRICATO IN CINA • FABRICADO EN CHINA • VERVAARDIGD IN CHINA • FEITO NA CHINA • СДЕЛАНО В КИТАЕ

©2024 ALPHA All rights reserved. • Tous droits réservés. • Alle Rechte vorbehalten. • Tutti i diritti sono riservati. • Todos los derechos reservados. • Alle rechten voorbehouden. • Todos os direitos reservados. • Все права защищены.

EN. WARNING. CHOKING HAZARD - Small parts. Not for children under 3 years. FR. ATTENTION ! DANGER D'ETOUFFEMENT - Contient de petites pièces. Ne convient pas aux enfants de moins de trois ans. DE. ACHTUNG: ERSTICKUNGSGEFAHR - Kleinteile. Nicht für Kinder unter 3 Jahren geeignet. IT. AVVERTENZA: RISCHIO DI SOFFOCAMENTO - Pezzi piccoli. Non adatto a bambini al di sotto dei 3 anni. ES. ADVERTENCIAS: PELIGRO DE ASFIXIA - Contiene piezas pequeñas. No conveniente para niños menores de 3 años. NL. WAARSCHUWING: VERSTIKKINGSGEVAAR - Kleineonderdelen. Niet geschikt voor kinderen jonger dan 3 jaar. PT. AVISOS: PERIGODEASFIXIA - Peçaspequenas. Não indicado para crianças menores de 3 anos. RU. ОСТОРОЖНО! ОПАСНОСТЬ УДУШЬЯ - мелкие детали. Не рекомендуется детям до 3 лет.

Keep these instructions for future reference as they contain important information. • Conservez ces instructions pour référence ultérieure car elles contiennent des informations importantes. • Bewahren Sie diese Anleitung zum späteren Nachschlagen, da sie wichtige Informationen enthalten. • Conservare queste istruzioni come riferimento per il futuro poiché contengono delle informazioni importanti. • Mantenga estas instrucciones para futura referencia porque contiene información importante. • Bewaar deze instructies voor toekomstig gebruik, omdat ze belangrijke informatie bevatten. • Mantenha estas instruções para futura referência, já que contém informação importante. • Сохраните инструкцию для последующего использования, т.к. в ней содержится важная информация.

WARNING:
CHOKING HAZARD - Small parts.
Not for children under 3 years.

