

01

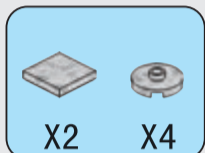

02

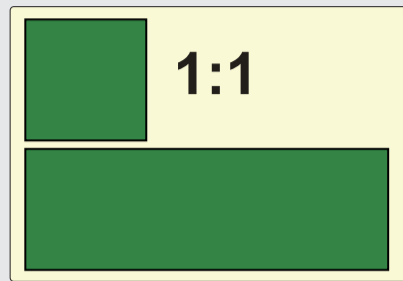
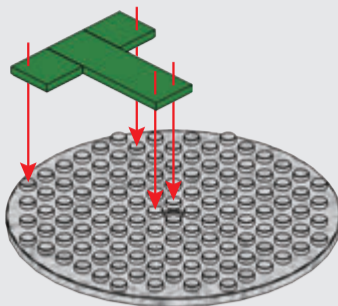
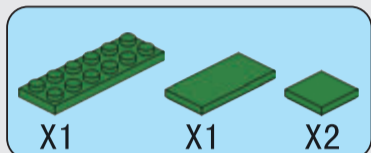
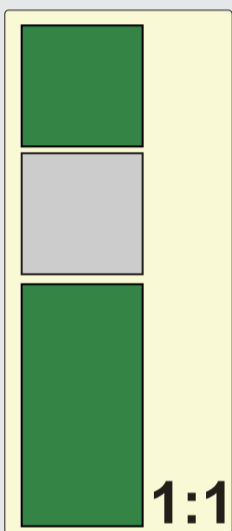
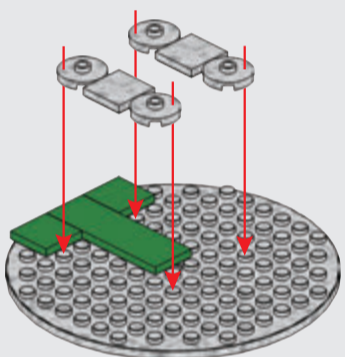

03

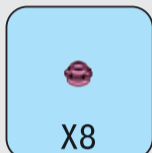
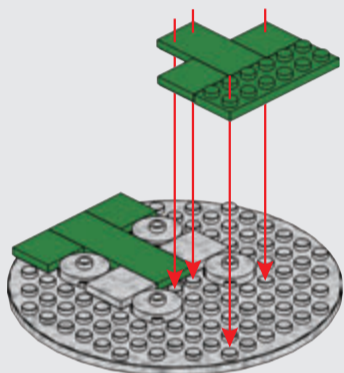

04

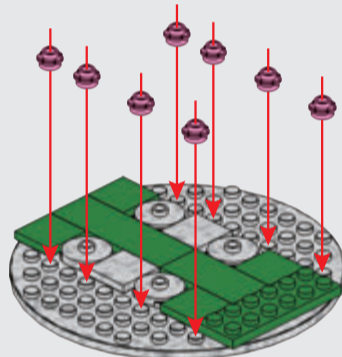

05

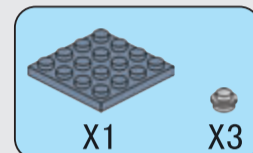
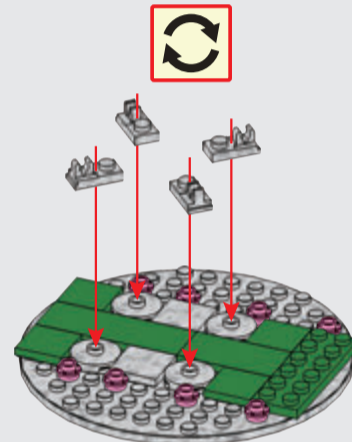

06

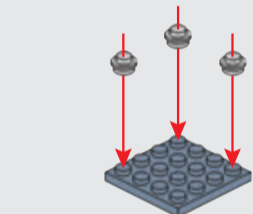

07

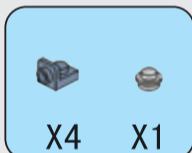
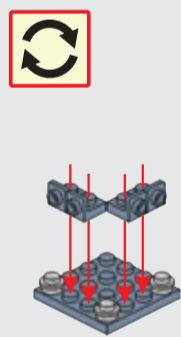

08

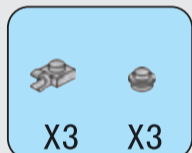
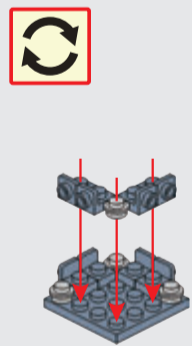

09

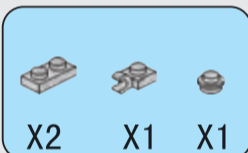
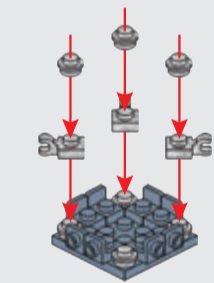

10

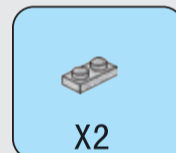
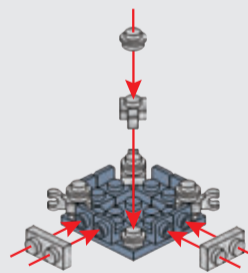

11

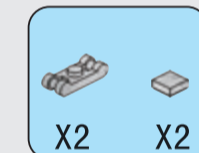
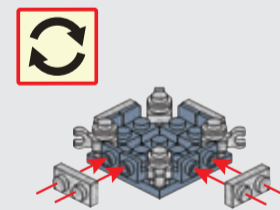

12

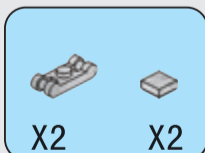
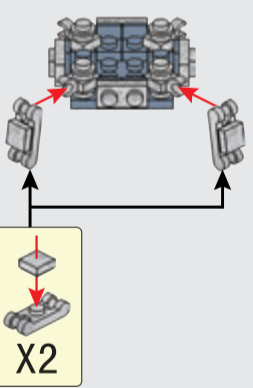

13

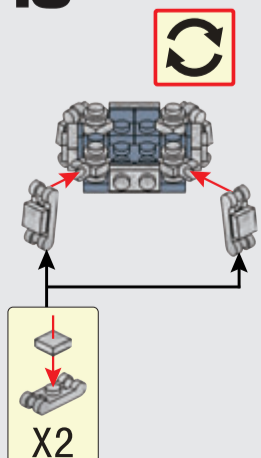

14

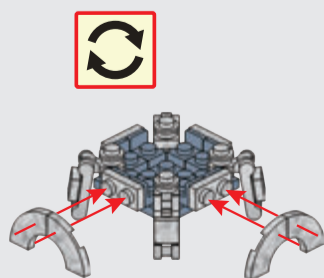

15

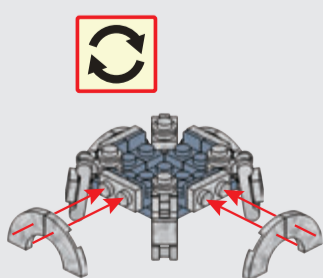

16

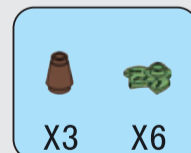
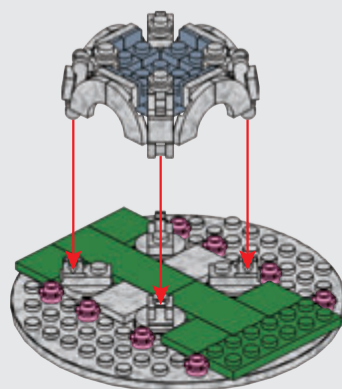

17

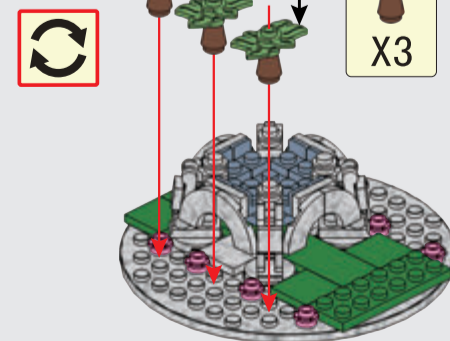

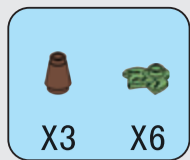

18

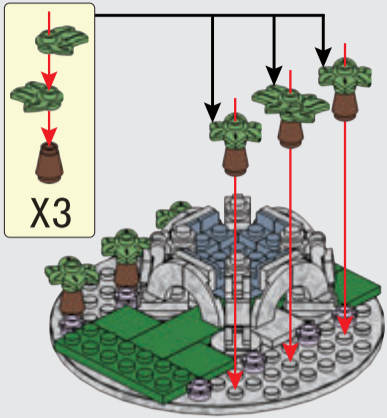

19

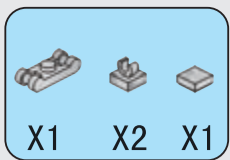
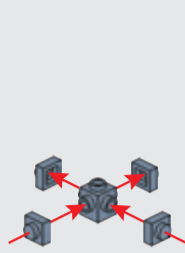

20

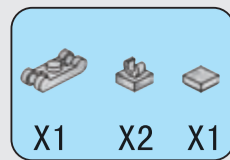
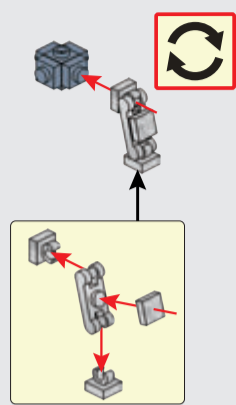

21

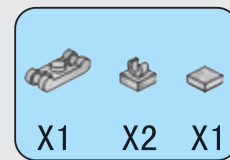
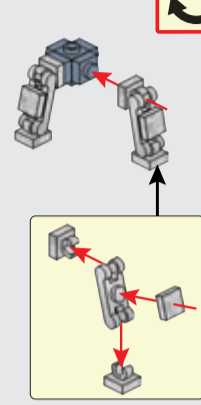

22

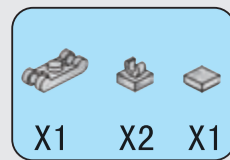
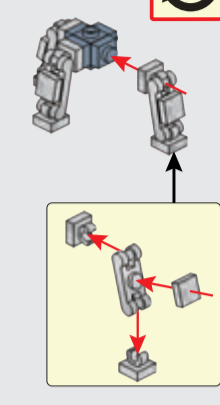

23

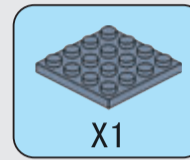
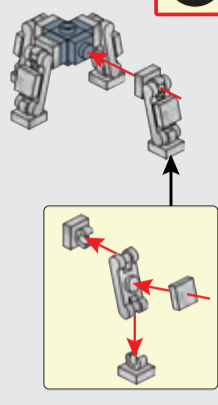

24

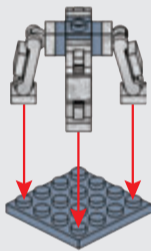

25

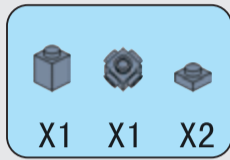
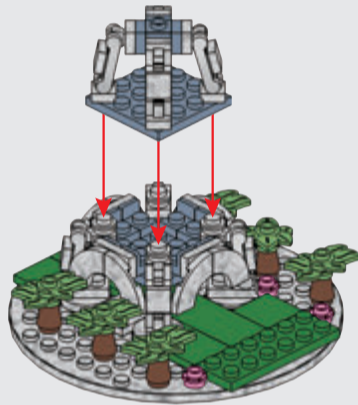

26

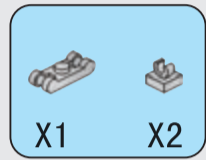

27

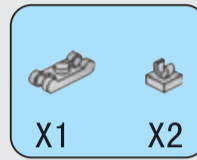
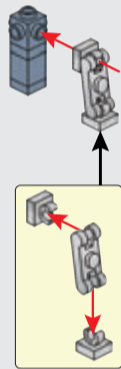

28

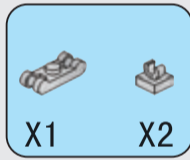
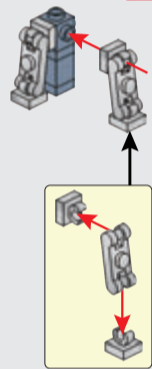

29

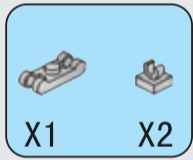
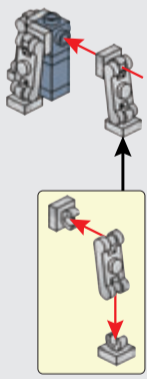

30

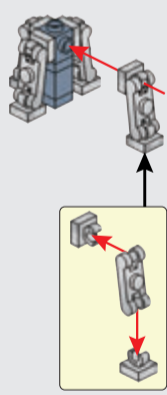

31

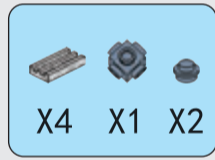
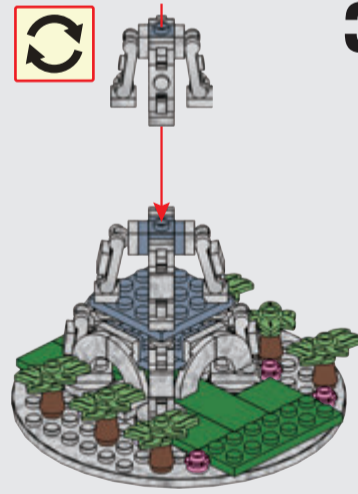

32

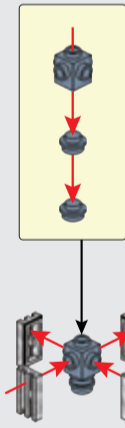

33

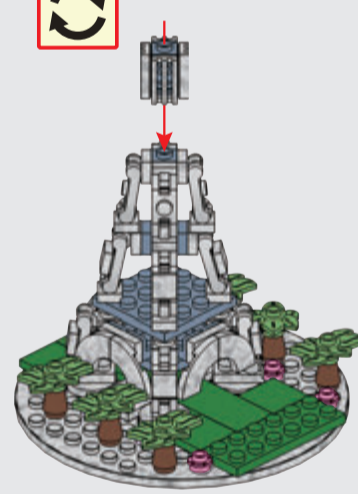

34

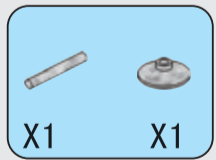
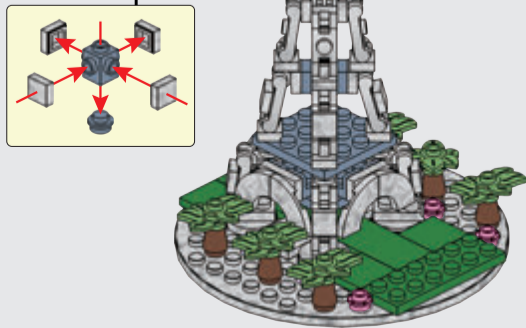

35

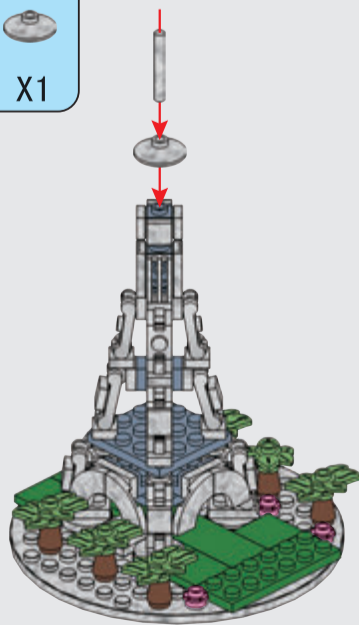

ALPHA GROUP CO., LTD.
Alpha Animation Industrial Area, Jinhong Road East & Fengxiang Road North, Chenghai District, Shantou, Guangdong, P.R.China(515800)
Tel: (86) 20-38983278 Fax:(86) 20-87358278
E-mail: auldeytoys@auldey.cn

AULDEY TOYS OF NORTH AMERICA, LLC.
13048 Valley Blvd, Fontana, CA92335, USA
Tel: 1-800-328-7363
customerservice@alphagroup-us.com
www.alphatoys.com

MADE IN CHINA • FABRIQUÉ EN CHINE • HERGESTELLT IN CHINA • FABBRICATO IN CINA • FABRICADO EN CHINA • VERVAARDIGD IN CHINA • FEITO NA CHINA • СДЕЛАНО В КИТАЕ

©2024 ALPHA All rights reserved. • Tous droits réservés. • Alle Rechte vorbehalten. • Tutti i diritti sono riservati. • Todos los derechos reservados. • Alle rechten voorbehouden. • Todos os direitos reservados. • Все права защищены.

EN. WARNING. CHOKING HAZARD - Small parts. Not for children under 3 years. FR. ATTENTION ! DANGER D'ETOUFFEMENT - Contient de petites pièces. Ne convient pas aux enfants de moins de trois ans. DE. ACHTUNG: ERSTICKUNGSGEFAHR - Kleinteile. Nicht für Kinder unter 3 Jahren geeignet. IT. AVVERTENZA: RISCHIO DI SOFFOCAMENTO - Pezzi piccoli. Non adatto a bambini al di sotto dei 3 anni. ES. ADVERTENCIAS: PELIGRO DE ASFIXIA - Contiene piezas pequeñas. No conveniente para niños menores de 3 años. NL. WAARSCHUWING: VERSTIKKINGSGEVAAR - Kleine onderdelen. Niet geschikt voor kinderen jonger dan 3 jaar. PT. AVISOS: PERIGODEASFIXIA - Peças pequenas. Não indicado para crianças menores de 3 anos. RU. ОСТОРОЖНО! ОПАСНОСТЬ УДУШЬЯ - мелкие детали. Не рекомендуется детям до 3 лет.

Keep these instructions for future reference as they contain important information. • Conservez ces instructions pour référence ultérieure car elles contiennent des informations importantes. • Bewahren Sie diese Anleitung zum späteren Nachschlagen, da sie wichtige Informationen enthalten. • Conservare queste istruzioni come riferimento per il futuro poiché contengono delle informazioni importanti. • Mantenga estas instrucciones para futura referencia porque contiene información importante. • Bewaar deze instructies voor toekomstig gebruik, omdat ze belangrijke informatie bevatten. • Mantenha estas instruções para futura referência, já que contém informação importante. • Сохраните инструкцию для последующего использования, т.к. в ней содержится важная информация.

⚠ **WARNING:**
CHOKING HAZARD - Small parts.
Not for children under 3 years.

